

FUEL PRESSURE REGULATOR ON-VEHICLE INSPECTION

CHECK FUEL PRESSURE

(See step 2 in on-vehicle inspection in fuel pump)

COMPONENTS FOR REMOVAL AND INSTALLATION

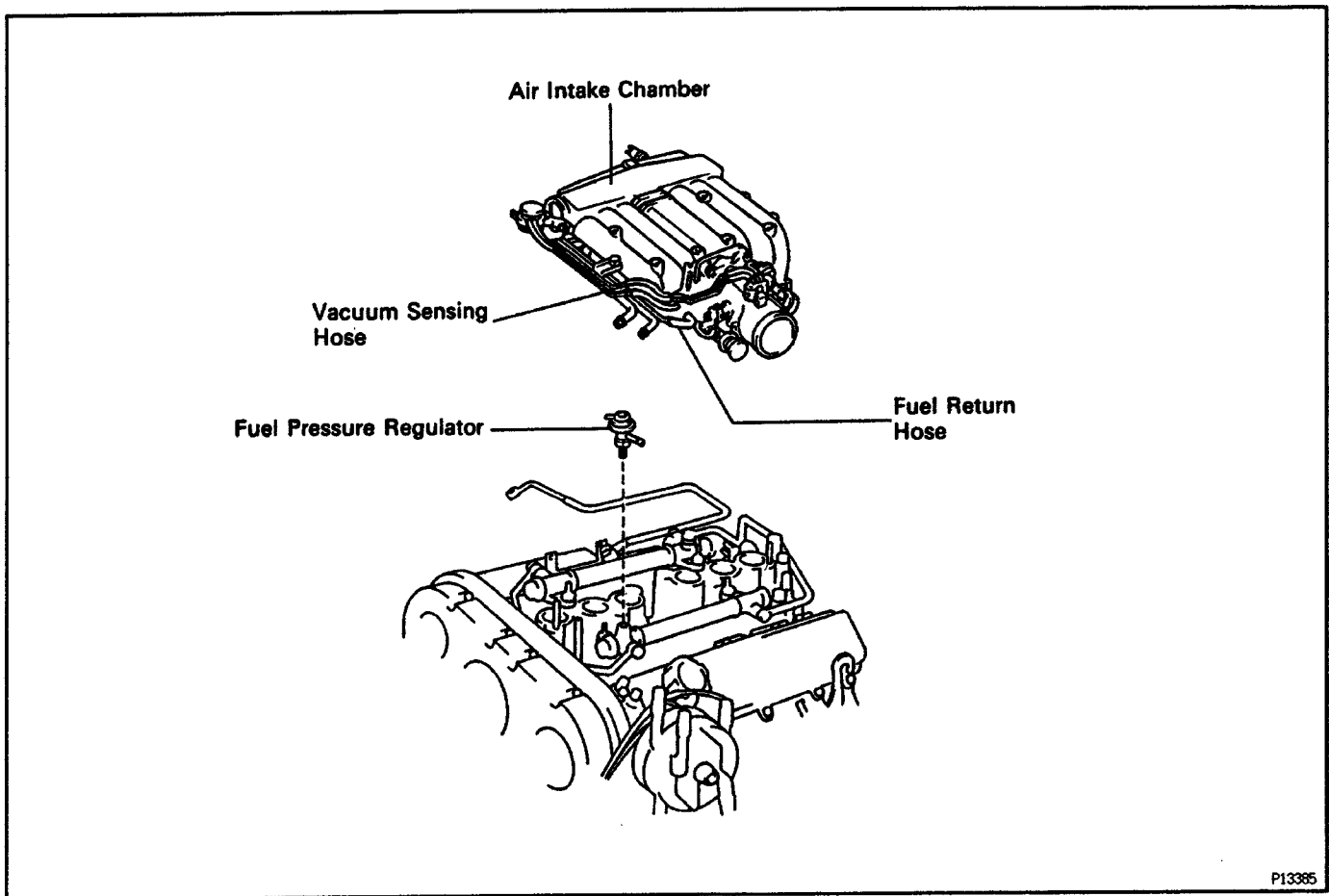

FUEL PRESSURE REGULATOR REMOVAL

1. DRAIN ENGINE COOLANT

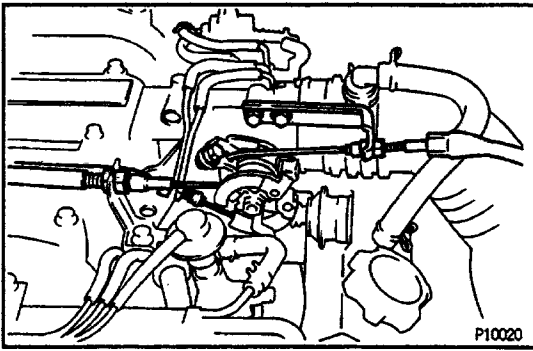

2. DISCONNECT THESE CABLES:

- (a) w/ Cruise control:
Actuator cable with bracket
- (b) Accelerator cable
- (c) A/T:
Throttle cable

3. DISCONNECT AIR CLEANER HOSE

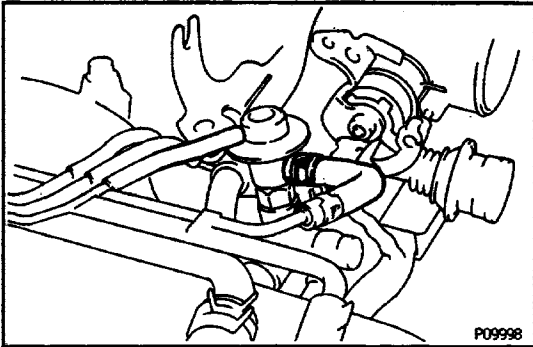

4. DISCONNECT VACUUM SENSING HOSE

6. DISCONNECT FUEL RETURN HOSE

- (a) Place a suitable container or shop towel under the fuel pressure regulator.
- (b) Disconnect the fuel return hose from the fuel pressure regulator.

6. REMOVE AIR INTAKE CHAMBER

- (a) Disconnect the throttle position sensor connector.
- (b) Disconnect the canister vacuum hose from the throttle body.

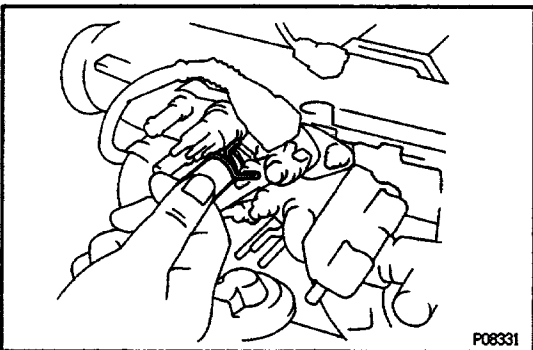

- (c) Disconnect the PCV hose from the union.

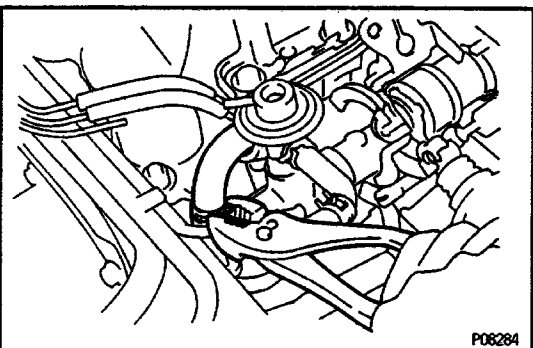

- (d) Disconnect the No.4 water bypass hose from the union of the intake manifold.

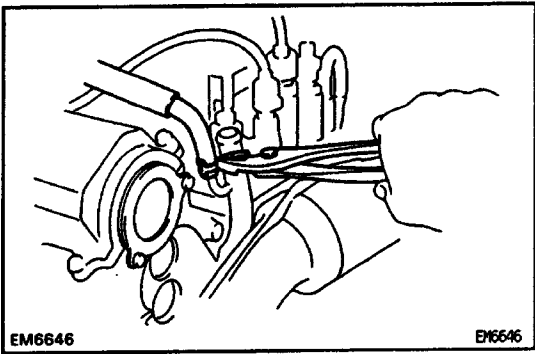

- (e) Disconnect the No.5 water bypass hose from the water bypass pipe.

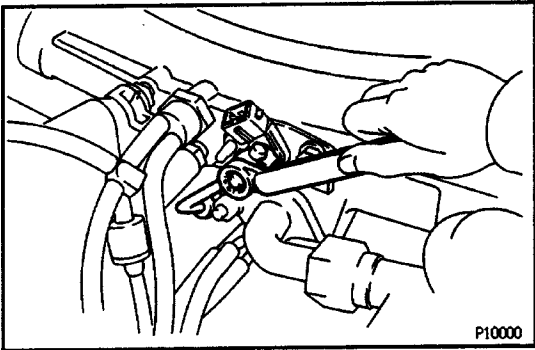

- (f) Disconnect the cold start injector connector.
 (g) Remove the union bolt, 2 gaskets and cold start injector tube.

- (h) Disconnect the vacuum hose from the gas filter.
 (i) Disconnect the EGR gas temp. sensor connector.
 (j) Disconnect the EGR vacuum hoses from the air pipe and EGR vacuum modulator.

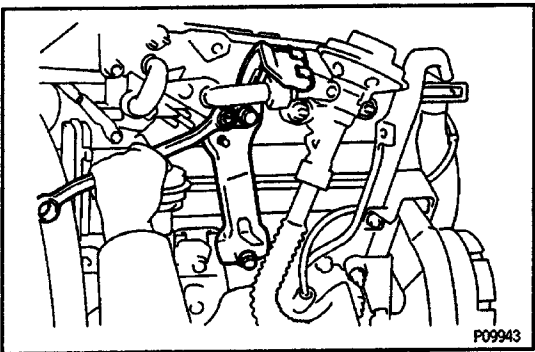

- (k) Remove the nut, 2 bolts, intake chamber stay and throttle cable bracket.

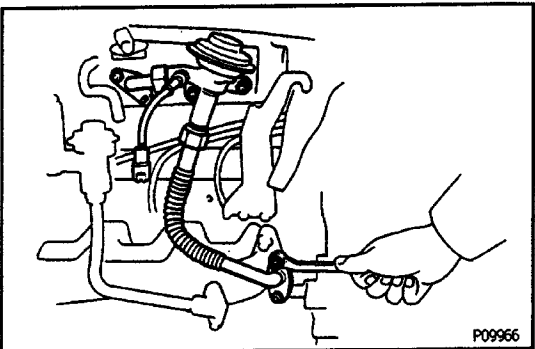

- (l) Remove the 5 nuts, EGR valve with the pipes and 2 gaskets.

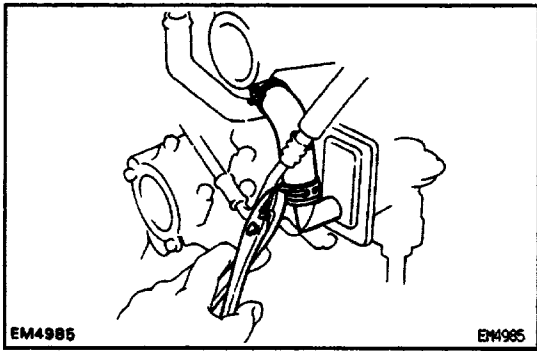

(m) Disconnect the No.1 air hose from the PAIR reed valve.

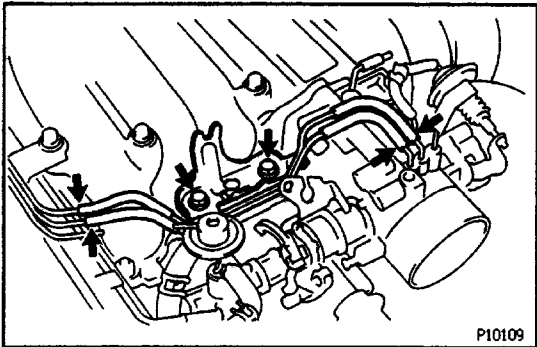

(n) Disconnect the 4 vacuum hoses from the air pipes.

(o) Remove the 2 bolts and accelerator cable bracket.

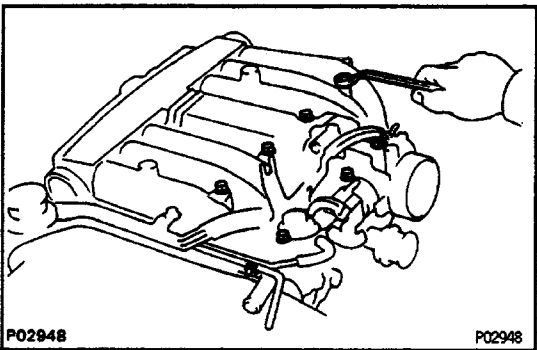

(p) Remove the 6 bolts, 2 nuts, intake chamber and gasket.

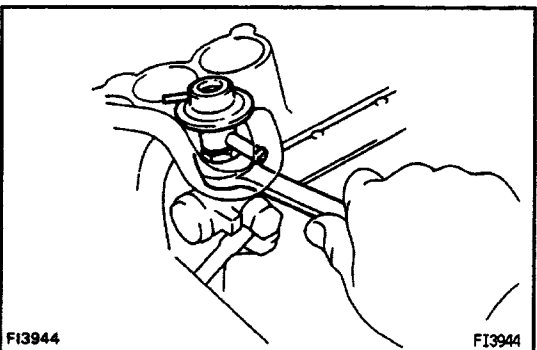

7. REMOVE FUEL PRESSURE REGULATOR

Loosen the lock nut, and remove the fuel pressure regulator.

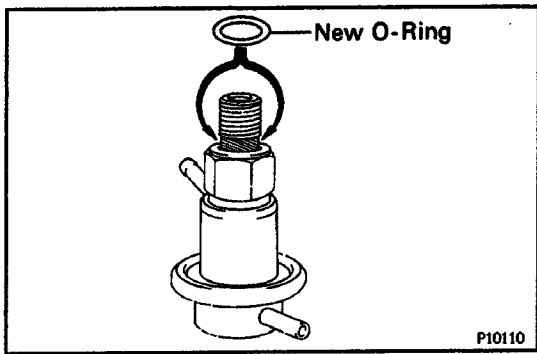

FUEL PRESSURE REGULATOR INSTALLATION

(See Components for Removal and Installation)

1. INSTALL FUEL PRESSURE REGULATOR

- (a) Fully loosen the lock nut of the fuel pressure regulator.
- (b) Apply a light coat of gasoline to a new O-ring and install it to the fuel pressure regulator.
- (c) Thrust the fuel pressure regulator completely into the delivery pipe by hand.
- (d) Turn the fuel pressure regulator counterclockwise until the outlet faces in the direction indicated in the illustration.

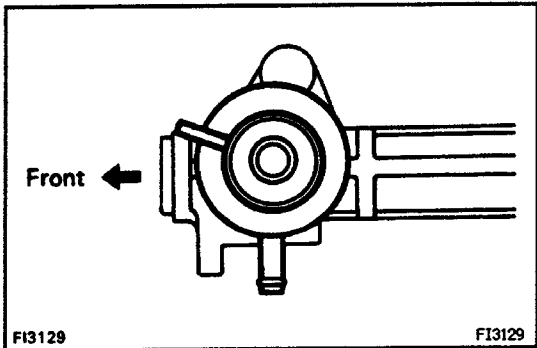

- (e) Torque the lock nut.
Torque: 29 N-m (300 kgf-cm, 22 ft-lbf)

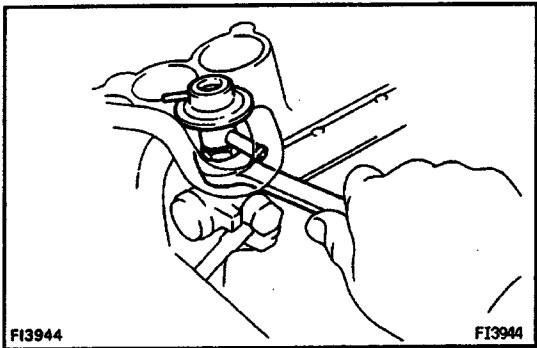

2. INSTALL AIR INTAKE CHAMBER

- (a) Position a new gasket on the intake manifold.
- (b) Install the intake chamber with the 6 bolts and 2 nuts.
Torque: 18 N-m (185 kgf-cm, 13 ft-lbf)

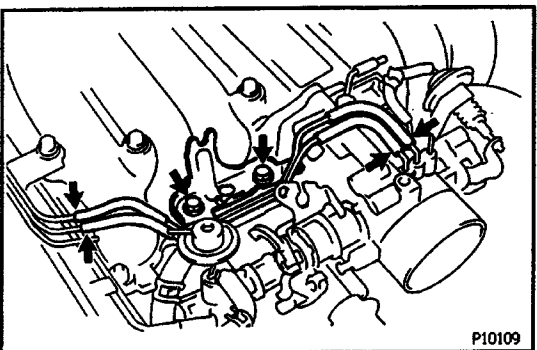
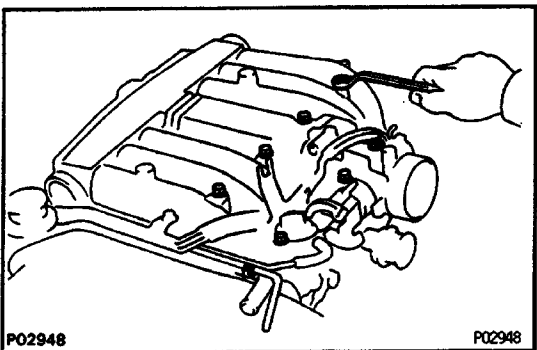

- (c) Install the accelerator cable bracket with the 2 bolts.
- (d) Connect the 4 vacuum hoses to the air pipes.

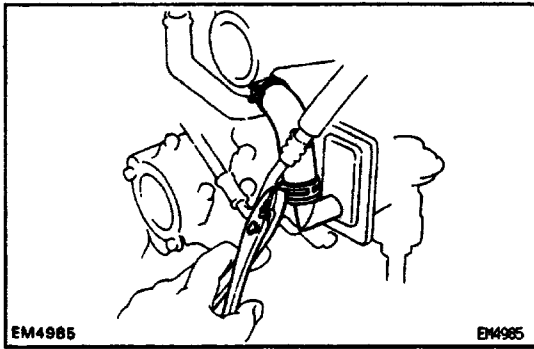

(s) Connect the No. 1 air hose to the reed valve.

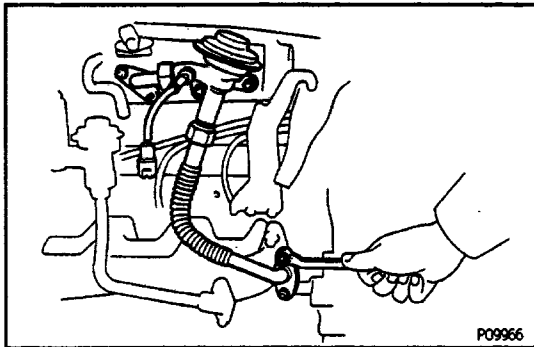

(f) Position 2 new gaskets to the intake chamber and RH exhaust manifold.

(g) Install the EGR valve with the pipes to the intake chamber and RH exhaust manifold.

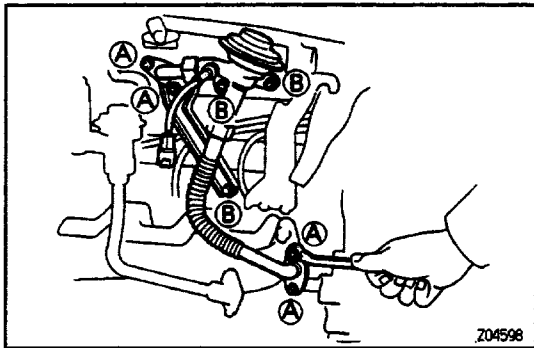

(h) Install the air intake chamber stay and throttle cable bracket. Install and torque the 6 nuts and 2 bolts.

Torque:

(A): 29 N-m (300 kgf-cm, 22 ft-lbf)

(B): 18 N-m (185 kgf-cm, 13 ft-lbf)

(i) Connect the EGR hoses to the air pipe and EGR vacuum modulator.

(j) Connect the EGR gas temp. sensor connector.

(k) Connect the vacuum hose to the gas filter.

(l) Connect the cold start injector tube with new a gasket and the union bolt.

Torque: 15 N-m (150 kgf-cm, 13 ft-lbf)

(m) Connect the cold start injector connector.

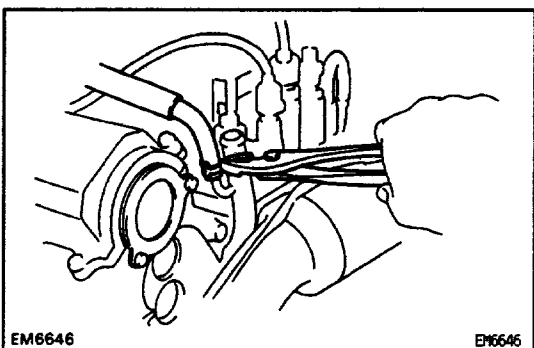
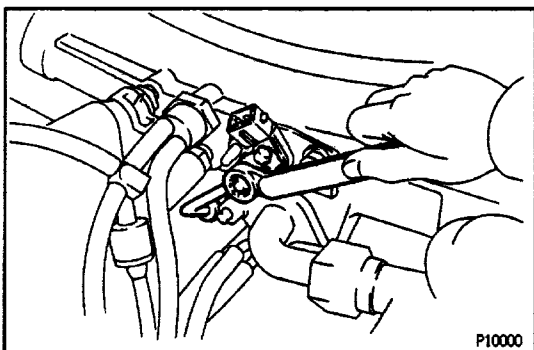

(n) Install the No.5 water bypass hose to the water bypass pipe.

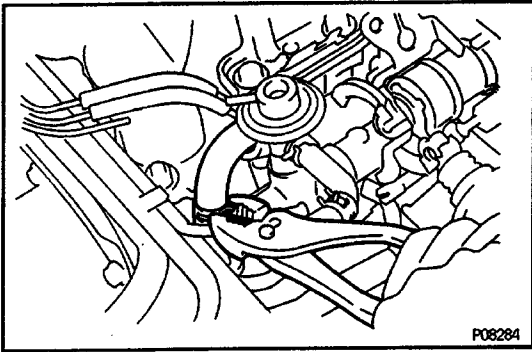

- (o) Connect the No.4 water bypass hose to the union of the intake manifold.

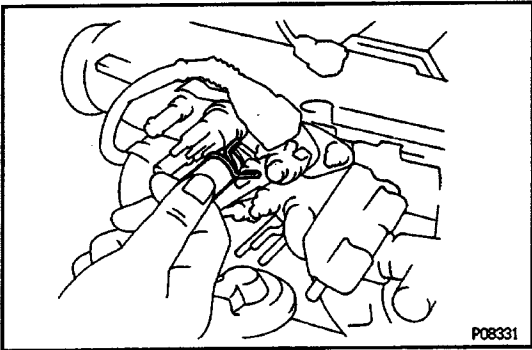

- (p) Connect the PCV hose to the union.
 (q) Connect the canister vacuum hose to the throttle body.
 (r) Connect the throttle position sensor connector.

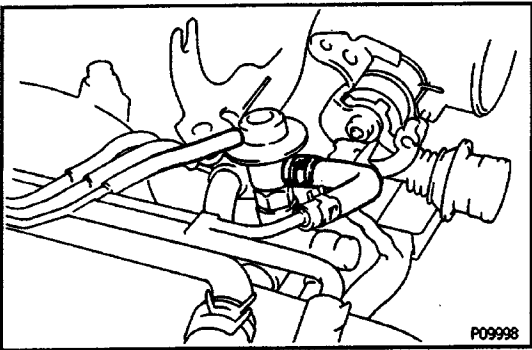

- 3. CONNECT FUEL RETURN HOSE**
4. CONNECT VACUUM SENSING HOSE
5. CONNECT AIR CLEANER HOSE

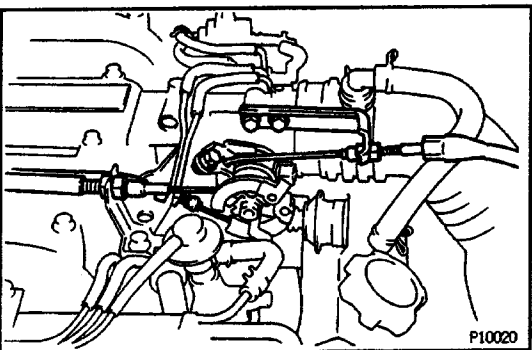

6. CONNECT THESE CABLES:

- (a) A/T:
 Throttle cable
 (b) Accelerator cable
 (c) w/ Cruise control:
 Actuator cable with bracket

7. REFILL WITH ENGINE COOLANT

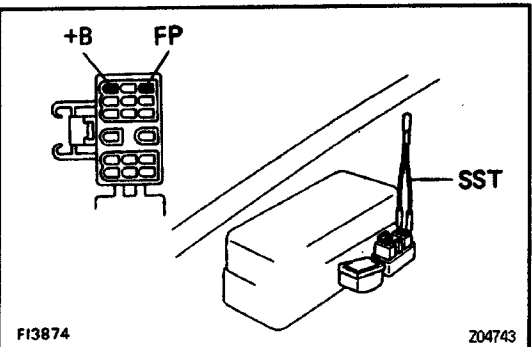

8. CHECK FOR FUEL LEAKAGE

- (a) With the ignition switch ON, use SST to connect terminals FP and +B of the DLC1.
 SST 09843-18020
 (b) Check for fuel leakage. .
 (c) Remove SST from the DLC1.